

GIGACORE 16tf

Ethernet Switch

User manual



Description: User Manual GigaCore 16t. REVISION: 20250323-REV 0.0.4



General information



The lightning flash with arrowhead symbol, within an equilateral triangle, is intended to alert the user to the presence of uninsulated “dangerous voltage” within the product’s enclosure that may be of sufficient magnitude to constitute a risk of electric shock to persons.

L'éclair avec une flèche à l'intérieur d'un triangle équilatéral est destiné à attirer l'attention de l'utilisateur sur la présence d'une « tension dangereuse » non isolée à l'intérieur de l'appareil, pouvant être suffisamment élevée pour constituer un risque d'électrocution.



The exclamation point within an equilateral triangle is intended to alert the user to the presence of important operating and maintenance (servicing) instructions in the literature accompanying the appliance.

Le point d'exclamation à l'intérieur d'un triangle équilatéral est destiné à attirer l'attention de l'utilisateur sur la présence d'instructions importantes sur l'emploi ou la maintenance (réparation) de l'appareil dans la documentation fournie.

CAUTION

TO REDUCE THE RISK OF FIRE OR ELECTRIC SHOCK, DO NOT EXPOSE THIS APPARATUS TO RAIN OR MOISTURE.

AVERTISSEMENT

POUR RÉDUIRE LES RISQUES D'INCENDIE OU DE DÉCHARGE ÉLECTRIQUE, N'ÉPOSEZ PAS CET APPAREIL À LA PLUIE OU À L'HUMIDITÉ.

CAUTION

OTHER THAN THE FIBER PORTS, NO USER SERVICEABLE PARTS INSIDE. REFER SERVICING TO QUALIFIED SERVICE PERSONNEL.

AVERTISSEMENT

AUCUNE PIÈCE CONTENUE À L'INTÉRIEUR NE PEUT ÊTRE RÉPARÉE PAR L'UTILISATEUR, VEUILLEZ CONFIER TOUTE RÉPARATION À UN PERSONNEL QUALIFIÉ.

FCC Compliance Statement:

This device complies with Part 15 of the FCC Rules. Operation is subject to the following two conditions: (1) this device may not cause harmful interference, and (2) this device must accept any interference received; including interference that may cause undesired operation.



IMPORTANT NOTICE: DO NOT MODIFY THIS UNIT!

This product, when installed as indicated in the instructions contained in this manual, meets FCC requirements. Modifications not expressly approved by Luminex Lighting Control Equipment nv may void your authority, granted by the FCC, to use the product.

This Equipment has been tested and found to comply with the limits for a Class A digital device, pursuant to Part 15 of the FCC rules. These limits are designed to provide reasonable protection against harmful interference when the equipment is operated in a commercial environment.

This equipment generates, uses and can radiate radio frequency energy and, if not installed and used in accordance with the instructions, may cause harmful interference to radio communications. Operation of this equipment in a residential area is likely to cause harmful interference in which case the user will be required to correct the interference at his own expense.

Industry Canada compliance statement

This Class A digital apparatus complies with Canadian ICES-003. Cet appareil numérique de la classe A est conforme à la norme NMB-003 du Canada.

European Community Compliance Statement

This is a class A product. In a domestic environment, this product may cause radio interference in which case the user may be required to take adequate measures.



**Disposal of Waste Equipment by users in the European Union
Information for Users on Collection and Disposal of Old Equipment.**

This symbol on the products, packaging, and/or accompanying documents means that used electrical and electronic products should not be mixed with general household waste.

For proper treatment, recovery, and recycling of old products, please take them to applicable collection points, in accordance with your national legislation and the Directives 2002/96/EC. By disposing of these products correctly, you will help to save valuable resources and prevent any potential negative effects on human health and the environment which could otherwise arise from inappropriate waste handling. For more information about collection and recycling of old products, please contact your local municipality, your waste disposal service, or the point of sale where you purchased the items.

[For business users in the European Union]

If you wish to discard electrical and electronic equipment, please contact your dealer or supplier for further information.

[Information on Disposal in other Countries outside the European Union]

This symbol is only valid in the European Union. If you wish to discard these items, please contact your local authorities or dealer and ask for the correct method of disposal.

Warranty information

Limited warranty

Unless otherwise stated, your product is covered by a two (2) years parts and labour limited warranty. It is the owner's responsibility to furnish receipts or invoices for verification of purchase, date, and dealer or distributor. If purchase date cannot be provided, date of manufacture will be used to determine warranty period.

Returning under warranty

Any product unit or parts returned to Luminex LCE must be packaged in a suitable manner to ensure the protection of such product unit or parts, and such package shall be clearly and prominently marked to indicate that the package contains returned product units or parts.

Accompany all returned product units or parts with a written explanation of the alleged problem or malfunction.

Freight

All shipping will be paid by the purchaser. Items under warranty shall have return shipping paid by the manufacturer only in the European Union. Under no circumstances will freight collect shipments be accepted.

Prepaid shipping does not include rush expediting such as air freight. Air freight can be sent customer collect in the European Union. Warranty is void if the product is misused, damaged, modified in any way, or for unauthorized repairs or parts.

Important safety instructions



BEFORE USING THIS PRODUCT, CAREFULLY READ THE APPLICABLE ITEMS OF THE FOLLOWING SAFETY INSTRUCTIONS:

- Read these instructions.
- Keep these instructions.
- Pay attention to all warnings.
- Follow all instructions.
- Do not use this apparatus near water.
- Clean only with dry cloth.
- Do not block any ventilation openings. Install in accordance with the manufacturer's instructions.
- Do not install near any heat sources such as radiators, heat registers, stoves, or other apparatus that produce heat.
- Protect the power cord from being walked on or pinched particularly at plugs, convenience receptacles, and the point where they exit from the apparatus.
- Only use attachments/accessories specified by the manufacturer.
- Unplug this apparatus during lightning storms or when unused for long periods of time.
- Refer all servicing to qualified service personnel. Servicing is required when the apparatus has been damaged in any way such as:
 - Power-supply cable or plug is damaged.
 - Liquid has been spilled into the apparatus.
 - An object has fallen into the apparatus.
 - The unit has been exposed to rain or moisture.
 - The unit does not operate normally.
 - The unit was dropped or the chassis is damaged.
- To prevent your product from overheating, do not operate it in an area that exceeds the maximum recommended ambient temperature of 50°C for the GigaCore 16tf and for the GigaCore 16tf with PoE.
- The equipment should be installed in an area that it is unlikely for children to have access to the equipment.
- The equipment must be installed and protected from rain and humidity.
- The equipment requires a building installation protection of maximum 20A or less.
- Apparatus with mains power connection must be earthed!



WARNING: Avoid electric shock and fire hazard! Do not defeat the safety purpose of the polarized or grounding-type plug. A polarized plug has two blades with one wider than the other. A grounding type plug has two blades and a third grounding prong. The wide blade or the third prong are provided for your safety. If the provided plug does not fit into your outlet, consult an electrician for replacement of the obsolete outlet.

VENTILATION OPENINGS:

The system heat vents, located at the front and rear, dissipate heat. Do not block these openings. Leave at least 5 inches / 127 mm of space at the left and right of the switch for proper ventilation. Be reminded that without proper heat dissipation and air circulation, system components might overheat, which could lead to system failure or even severely damage components.

POWER CABLE:

Use only approved power cables. If you have not been provided with a power cable for your system or for any AC powered option intended for your system, purchase a power cable that is approved for use in your country. The power cable must be rated for the product and for the voltage and current marked on the product's electrical ratings label. The voltage and current rating of the cable should be greater than the ratings marked on the product.



WARNING!! USE A MAINS POWER-IN CABLE WITH A MAXIMUM LENGTH OF 3M AND A MINIMUM CABLE CROSS SECTION OF 1.5MM².

DISCONNECT DEVICE:

The powerCON TRUE1 and DC input for the redundant PSU must be accessible at all times, because it serves as the main disconnecting device. Disconnect the power cables during installation of the device.

SAFETY CLASSIFICATION OF MAINS POWER INPUT:

- Mains input - powerCON TRUE1 input connection has a safety status of PRIMARY or ES3/PS3 CIRCUIT.
- Mains output - powerCON TRUE1 output connection has a safety status of PRIMARY or ES3/PS3 CIRCUIT.
- Redundant PSU port 57V connections have a safety status of ES1/PS3.

SAFETY CLASSIFICATION OF TRAFFIC PORTS:

- 10/100/1000 Base-T ports have a safety status of ES1/PS2.



CAUTION/ SHOCK HAZARD

RISK OF ELECTRIC SHOCK DO NOT OPEN. THIS UNIT HAS MORE THAN ONE POWER SUPPLY.
DISCONNECT ALL SUPPLIES BEFORE SERVICING TO AVOID ELECTRIC SHOCK

ATTENTION/ RISQUE D'ÉLECTROCUTION

RISQUE DE CHOC ELECTRIC NE PAS OUVRIR. CET APPAREIL COMPORTE PLUS D'UN CORDON D'ALIMENTATION, AFIN DE PREVENIR LES CHOCS ELECTRIQUES, DEBRANCHER LES CORDONS D'ALIMENTATION AVANT LE DEPANNAGE.

WELCOME TO YOUR GIGACORE 16tf.

Upon unpacking your new GigaCore 16tf, the E-ink display will display a QR-code. After scanning this QR-code, the safety manual and quick start guide will be opened on the device used to scan the QR code.

Once the device has been powered up and booted, this QR-code will disappear and not come back on any subsequent boot-up.

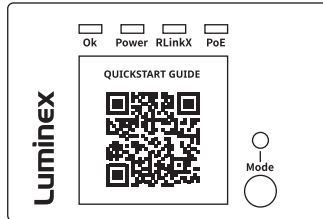

Table of Contents

GENERAL INFORMATION	. 2
WARRANTY INFORMATION	. 3
IMPORTANT SAFETY INSTRUCTIONS	. 4
1. APPLICATIONS	. 9
2. INSTALLATION	. 11
2.1 Mounting the device	.11
Rack mount	.11
2.2 Power up the device	.11
2.3 DESCRIPTION	.12
2.4 LED indicators	.14
2.5 Connection to the web interface.	.15
2.6 Reset	.15
Reset via the front panel	.15
Reset via Araneo	.15
3. GIGACORE FEATURES EXPLAINED	. 16
3.1 RLinkX	.16
Prerequisites	.17
Partial Redundancy	.17
RLinkX Port Mode Colours	.17
Global RLinkX Status LED	.18
Web Interface	.18
3.2 Groups (VLANs)	.18
3.3 MultiLinkX	.19
1 + 1 is NOT 2!	.19
4. CONFIGURATION	. 20
Web Interface Presentation	.20
4.1 Status Page.	.20
4.2 Groups/Trunks	.22
Group/VLAN Advanced settings	.23
Add or edit a Trunk	.24
Delete a trunk	.24
4.3 Port settings	.24
Available port speeds for port 1-12	.25
Available port speeds for port 13-16	.25

TABLE OF CONTENT

- 4.4 Device settings25
 - IP Settings25
 - ID Settings26
 - Security26
 - Device Info26
 - General PoE Settings26
 - SNMP26
 - Reset OptionS26
 - LED Brightness27
 - E-ink settings27

- 4.4 Toolbox27
 - Profile Manager27
 - Firmware28
 - Reset28
 - Reboot28

- 5. RESET 29**
 - 5.1 Reset29
 - 5.2 Reload defaults30
 - 5.3 Factory Reset30

- 6. TECHNICAL SUPPORT 31**

- 7. TECHNICAL SPECIFICATIONS 32**
 - GigaCore 16tf32

1. Applications

The GigaCore 16tf is a 10 Gigabit Ethernet switch for Professional touring applications in lighting, audio and video with a frequent tear-down & built-up requirement or for any other application where ruggedized connectivity is necessary.

It is designed to support the most advanced AV protocols out of the box and is the backbone for a converged network, allowing multiple applications to co-exist on the same network.

GigaCore 16tf provides ruggedised connectivity at the front and rear of the rack to accommodate multiple edge devices.

The combination of GigaCore 16tf and Araneo software platform is the ideal solution to deploy an entire AV network in just a few clicks.

Each GigaCore switch can be configured by an intuitive built-in AV Web UI.

Araneo, the network monitoring, planning and management software will ensure consistent management across the entire Luminex network.

The use of Araneo together with GigaCore switches will increase your productivity and confidence in the network as well as significantly reduce commissioning time.

An e-ink display informs the user about important parameters of the switch also when the device is not powered.

GigaCore 16tf is an indispensable part of any mobile AV network where reliability and a quick and easy setup are needed.

As a user, you don't need to make choices nor tradeoffs as GigaCore manages most AV protocols for you out of the box: Pre-defined QoS/DiffServ (Quality of Service) settings, optimized IGMP (Internet Group Management Protocol) per group (VLAN) and pre-defined yet editable groups (VLANs) to easily separate your network in different applications making converged networks obvious, easy, and reliable.

Also included out of the box, is the advanced, automated redundancy protocol RLinkX that ensures redundant links and ring topology within your GigaCore network.

Bandwidth, connectivity, and port availability are not an issue anymore with 4 x independent ruggedized fiber connectors, available in multiple configurations (2 on the front and 2 on the back OR 4 on the back) and capable of data transfer speeds of up to 10 Gbps. 12 x 1Gbps copper ports with rugged EtherCON connectors ensure robust connectivity.

Time synchronization is crucial in many applications; GigaCore 16tf offers you a hassle free PTPv2 enabled switch which will work for most major audio protocols (e.g., AES67, ST2110, Dante, Q-sys/Q-lan, ...) without the need for making complicated configurations. Furthermore AVB/MILAN is supported out of the box on the management group (VLAN) and can operate simultaneously with the aforementioned PTPv2 applications in a converged network on different Groups (VLANs).

Entertainment and touring setups constantly push the limits. The deployment of PoE powered devices is continuously increasing. GigaCore 16tf is ahead of this trend by offering PoE++ as an option on all copper ports (90W per port with a total PoE budget of up to 500W – stand-alone unit or up to 1000W - when used in conjunction with a separate RPSU unit).

Alternatively, this separately available RPSU unit can also guarantee redundant power if a large total PoE budget is not needed for the application. (Note the second PSU connectivity is only offered on the PoE++Models.)

Great care has been taken to ensure silent operation by means of intelligent fan control, giving you more options with peace of mind that no live audience or recording session would be disturbed.

GigaCore 16tf is the ideal touring network solution offering rugged, out of the box performance and #convergednetworkingmadeeasy.

A few examples of applications where the GigaCore 16tf can be used:

- Live events
- Film Studios/Convention centers
- Touring
- Large system integrations
- Sports arenas
- Convention centres
- Broadcast and recording studios, OB vans
- Theme parks
- ...

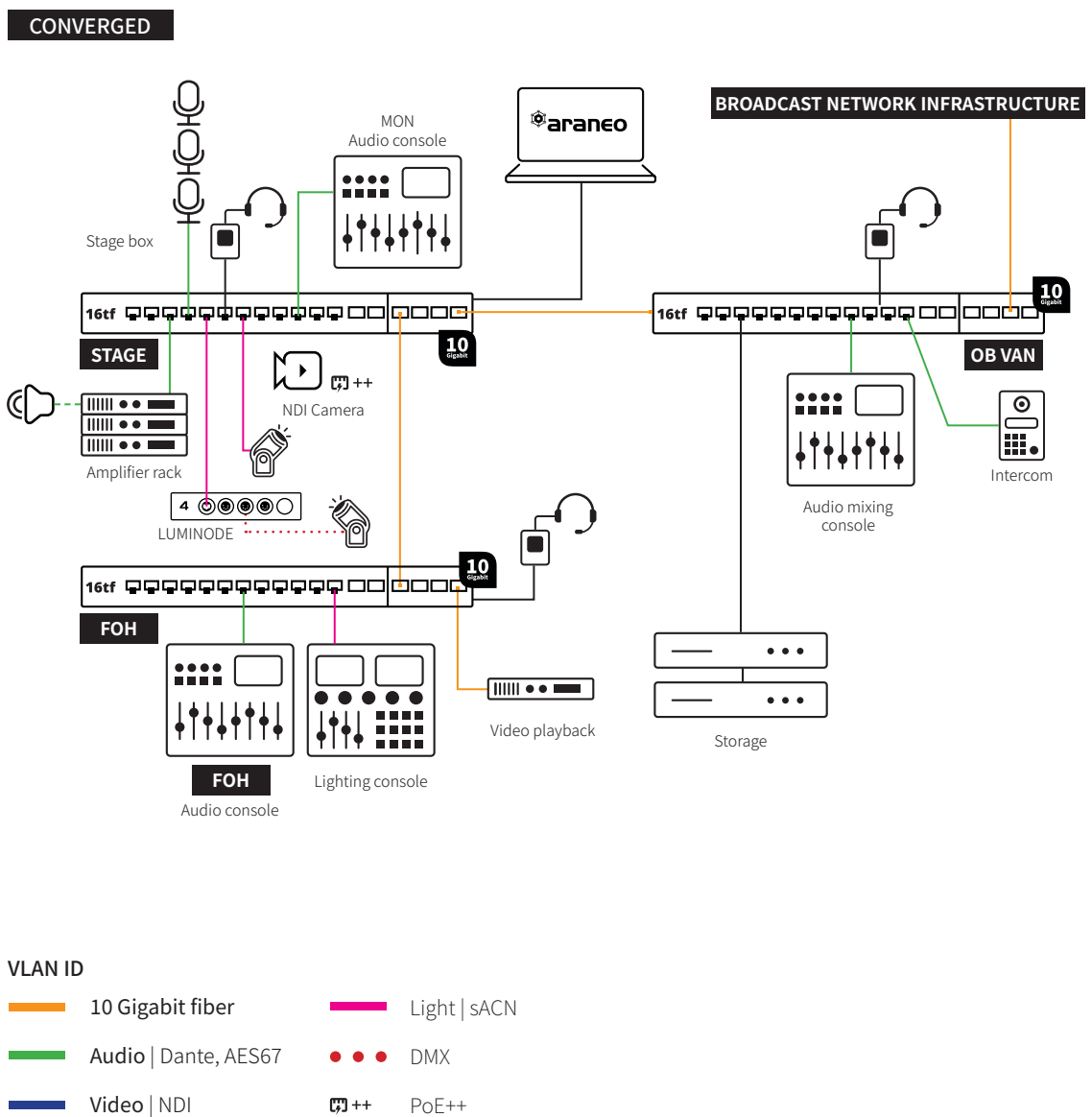

2. Installation

2.1 Mounting the device

GigaCore 16tf is designed to be rack mounted. Please read the following instructions to make sure the device is mounted and secured correctly.

RACK MOUNT

The GigaCore 16tf is designed to be fitted in a standard 19-inch rack, you need 4 rack screws to mount the device.

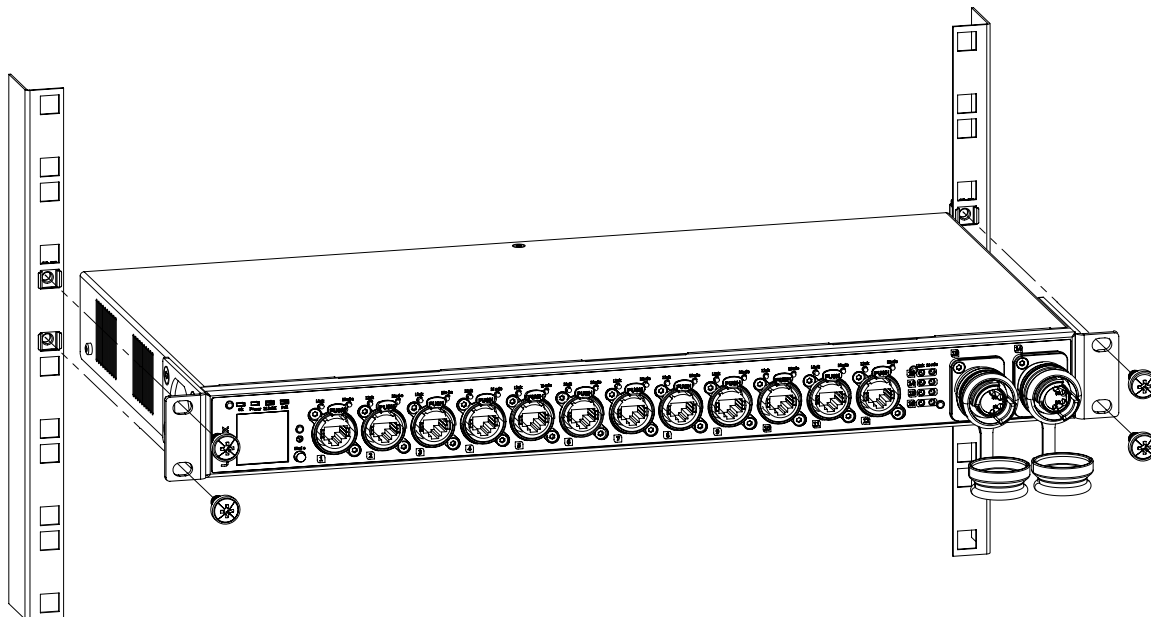

2.2 Power up the device

Power-up the device with a power cable with Neutrik PowerCON TRUE1 connection (A) (please contact your local dealer if you do not have a suitable power cable at hand). The device will automatically switch on. To shut it down after use, just unplug the power cable again.

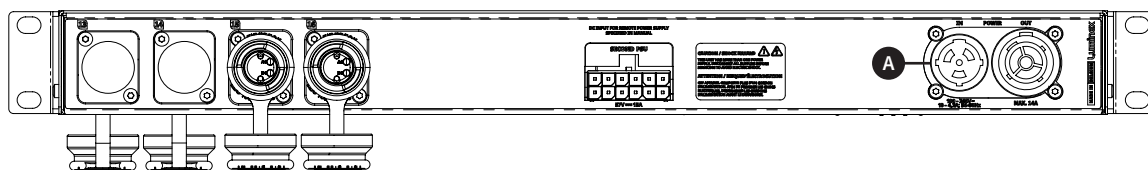

After connecting the power cable correctly, the power LED indicator on the front panel will light up green. The GigaCore 16tf requires standard AC power 100-240VAC, 50/60Hz. Current required, depends on the model.

Please use an PowerCON TRUE1 compliant cable to power the device. When installing a new connector, please refer to the following wire colour code reference:

Wire*	Connection
Green/Yellow	AC Ground
Blue	AC Neutral
Brown	AC Line

* International (Harmonised) Standard

2.3 DESCRIPTION

2.3.1 FRONT PANEL

(A) Status LEDs:

- OK: Indicates the general status of the switch.
- Power: Indicates the status of the power supply.
- RLinkX: Indicates the RLinkX status.
- PoE: Indicates the status of the PoE functionality and the PoE supply (GigaCore 16tf with PoE only).

(B) E-ink Display:

- E-ink display: Indicates the options the switch has been equipped with and the IP address (can be disabled in the settings).

(C) Mode:

- Mode LED: Indicates the selected state for the Mode LEDs (see the “LED indicators” section in this manual for more details).
- Mode button: Use this button to cycle through the different states of the port Mode LEDs.

(D) Locking ethernet ports:

- 12 x 1Gbps locking ethernet ports.

(E) Port LEDs:

- Port Mode: According to the selected state, the LED will show different colours.
- Port Link/Speed: Shows the current speed and link activity of a port.

(F) Representation of the optional D-Type ports:

- Shows the mode and link activity of the optional fiber optic / EtherCON ports.

(G) Optional D-Type ports:

- Up to 2 fiber optic or EtherCON port can be installed at the front, depending on the chosen configuration between front and rear options.

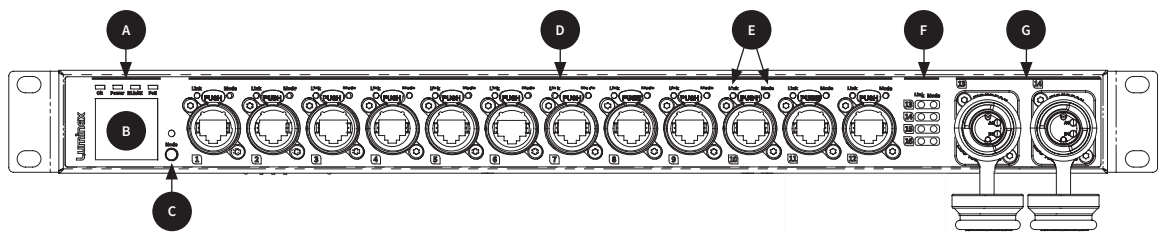

2.3.2 REAR PANEL

(H) Optional D-Type ports:

- Up to 4 fiber optic or EtherCON ports can be installed at the rear, depending on the chosen configuration between front and rear options

(I) Second PSU:

- DC input from an RPSU 5580 remote power supply (15A).

(J) Power:

- Neutrik PowerCON TRUE1 - In and Out.
- 16tf PoE: AC power 100 - 240VAC, 10 - 4.2A, 50 / 60Hz.
- 16tf: AC power 100 - 240VAC, 7 - 3A, 50 / 60Hz.
- Mains outlet: 14A max.

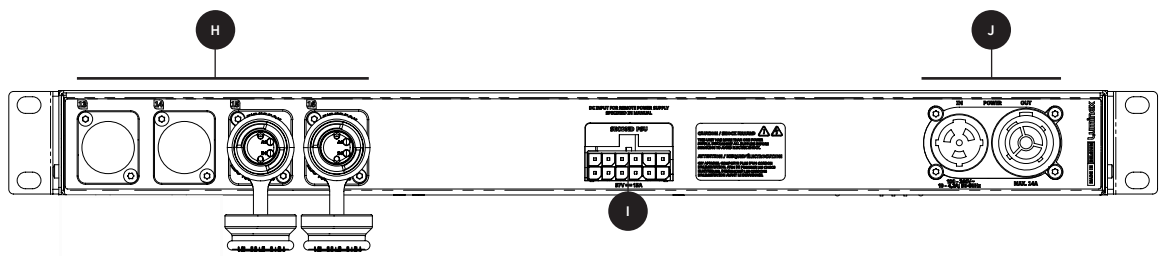

2.4 LED indicators

There are various LEDs on the GigaCore 16tf. Here is a list of the LEDs, the possible colours, and the meaning of each colour.

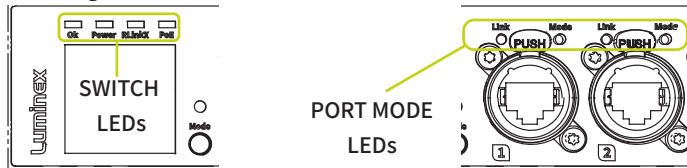

Switch LED	Status	Meaning
OK (General status LED)		
		Green All OK.
		Green flashing Unit is writing to the flash. Do not disconnect power.
		Orange Temperature warning.
		Red flashing Temperature or Fan error.
		Red/Green flashing The unit is flashing new firmware. Do not disconnect power.
Power LED		
		Green Normal operation for non PoE models. Second PSU connected and powered for PoE models.
		Orange No second PSU connected for PoE models.
		Red flashing PSU error.
RLinkX LED		
		Green RLinkX active.
PoE LED (GigaCore 16tf with PoE only)		
		Green Second PSU connected and powered with PoE models.
		Orange No second PSU connected with PoE models.
		Red PSU error.
Port LED	Status	Meaning
	Off	No link.
		Green Gigabit connection.
		Orange 10/100 Mbps connection.
		Blink Activity.
		White Group Colour

With the use of the mode button, the user can get all the necessary information immediately. Press the mode button to cycle through the different states.

State	Mode LED	Port Mode LED	Meaning
Groups	White	Group Colour	The LED colour indicates the group assignment of the port.
PoE	Yellow	Yellow	PoE is available on this port.
		Orange	Port is supplying PoE to a device.
		Red	Error with PoE.
RLinkX	Blue	Off	RLinkX is disabled on this port.
		Cyan	RLinkX is enabled on this port, but no redundancy.
		Orange	RLinkX partial redundancy or GigaCore in the ring that does not have the Group-Aware RLinkX functionality.
MultiLinkX	Magenta	Blue	Full redundancy: for all groups that are a member of this port. There is at least one redundant path.
		Magenta	MultiLinkX is enabled on this port.
Dark Mode	Off	Off	All port LEDs are switched off. Switch status LEDs remain available.

2.5 Connection to the web interface

- The GigaCore 16tf IP address can be found at the rear of the unit or on the E-ink display.
- Set your computer with a compliant IP address (do not use the same IP address!).
- Connect your computer to the GigaCore with a network cable.
- Launch your favourite web browser.
- Type the IP address of the GigaCore in the address field followed by enter.
- Use admin in the user field and leave the password field blank.



PLEASE KEEP IN MIND THE WEB INTERFACE OF A SWITCH CAN ONLY BE REACHED THROUGH A PORT ASSIGNED IN THE MANAGEMENT GROUP (FROM THE SWITCH YOU'RE CONNECTED TO, OR FROM ANOTHER SWITCH THROUGH AN ISL PORT). YOU NEED AT LEAST ONE PORT ASSIGNED TO THE MANAGEMENT GROUP IN YOUR ENTIRE NETWORK TO REACH THE WEB INTERFACE OF ALL YOUR GIGACORE SWITCHES.

FACTORY DEFAULT ALL PORTS ARE ASSIGNED TO THE MANAGEMENT GROUP

2.6 Reset

Sometimes it can come in handy to reset the device. The following methods are available to reset the GigaCore 16tf:

RESET VIA THE FRONT PANEL

- Press and hold the mode button for 5 seconds.
- When the four status LEDs are blinking red, release the mode button.
- The device will reset to factory default settings.

RESET VIA ARANEO

Araneo is available for Windows and MacOS and can be found in the download section of our website: <https://www.luminex.be/download-araneo/>

How to reset your GigaCore 16tf through Araneo:

- With a computer connected to the device, open Araneo (version 1.9.0 or above).
- Select the GigaCore you wish to reset.
- The Reset option becomes available on the Utilities section of the system tray at the bottom of your screen in Araneo:
- Choose if you want to keep the IP settings.
- Choose if you want to keep the profiles.
- Click reset.

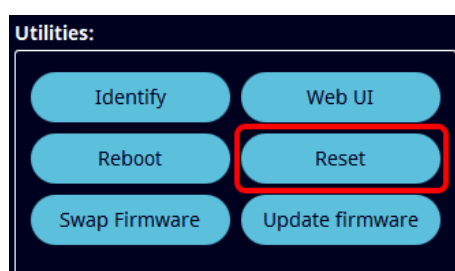

3. GigaCore Features Explained

The GigaCore range of switches offers many unique features which greatly simplify your everyday job. These features will be explained in the following paragraphs.

3.1 RLinkX

RLinkX, which stands for **Redundant Link** by **LumineX**, is an automated system to easily create redundant paths between your GigaCore switches. It has been a well known feature of the first generation of GigaCore switches.

Switches automatically create active and redundant paths, providing an effortless method to create safe networks. If one of the active paths fails, the switches will enable a redundant path in a seamless manner.

3.1.1 RSTP - Rapid Spanning Tree Protocol

RLinkX consists of two elements:

- The Luminex ring detection protocol.
- The Rapid Spanning Tree Protocol (RSTP) defined by IEEE.

RSTP is a network protocol that ensures that the logical network topology is loop-free. This allows the creation of a network 'ring' topology without triggering a packet storm. A ring topology can be very useful in the AV industry to create a redundant network: if one link would go down, the RSTP protocol would trigger a 'topology change notification' (TCN) and ensure that the logical network is redefined such that the network continues to operate.

RSTP is enabled on all ports that have RLinkX enabled. By default, GigaCore's come with RLinkX enabled on all ports.

3.1.2 Araneo

The Araneo network monitoring software has various tools to indicate the RSTP state:

- Dotted connections indicate discarding links. These are 'backup' connections that are currently not used to transmit data, but may become active if an active link would go down or if the topology would change.
- When the RSTP overlay is active:
 - The RSTP bridge priority is indicated above each GigaCore. This can easily be modified by using the settings icon next to the priority.
 - The root bridge for the topology of which the GigaCore is part, is indicated along with the priority of the root bridge. Using the 'locate' icon will bring you directly to the root bridge.
 - The RSTP port roles is shown on each port. Hovering over the icon will give the port state and port role.
 - "root" (in purple): root port connects to the root bridge. Root ports are always in the forwarding state.
 - "dsgn" (in green), designated: The designated port provides a redundant link to the same segment as the root port. Designated ports are in a forwarding state by default.
 - "back" (in orange), backup: The backup port provides a redundant link to the same segment as a designated port. Backup ports are in a discarding state by default and only forward traffic if they become designated ports.
 - "alt" (in red), alternate: The alternate port is in a discarding state by default.
 - "dsbl" (in grey), disabled: A disabled port is discarding, most often because there is no link active on this port.

3.1.3 New RLinkX ring detection explained

PREREQUISITES

Before trusting the RLinkX indication, the basic group configuration should be consistent across the whole network. Especially:

- All groups should be consistent:
 - VLAN IDs: a group should be assigned the same VLAN ID on each switch.
- All trunks should be consistent:
 - Untagged groups: the untagged group for a certain trunk should be the same on each switch.
 - Trunk members: a certain trunk should have the same set of groups on each switch.
 - Trunk group consistency: the groups within a trunk should be consistent on each switch.

Note that these consistencies can be easily verified with the ‘Health Check’ feature inside Araneo, located in the top right corner.

A second point of attention: RLinkX ring detection will only work on ports that are a member of the management group. So it only work on ports that are assigned to the management group or that are assigned to a trunk that contains the management group. GigaCore’s communicate with each other using a proprietary ‘RLinkX’ protocol, which is only done inside the management group.

Note that other ports can still have RLinkX enabled to benefit from RSTP functionality. RSTP isn’t limited to the management group, only the redundancy indication has this limitation. This means that other ports will not get the blue LED indication.

RLinkX ring detection will only work for a port if RLinkX is enabled for that port.

Please keep in mind that RLinkX is an indication, it is never a guarantee for redundancy, especially not if these prerequisites are not fulfilled or when the port is part of multiple loops.

PARTIAL REDUNDANCY

This detection mechanism introduces the principle of ‘partial redundancy’. This is an indication for a port on which at least 1 Group is redundant, but not all groups on that port are redundant, meaning that not all groups of that port are configured on all ports of the redundant ring.

3.1.4 Indications

The new RLinkX version now has multiple indications in different locations:

RLINKX PORT MODE COLOURS

By clicking the **“Mode”** button on your GigaCore, go to the RLinkX mode (Blue Mode). Ports can have the following colours:

Colour	Meaning
OFF	RLinkX disabled for this port.
Cyan	RLinkX enabled for this port, but no redundancy.
Orange	RLinkX partial redundancy or GigaCore in the ring that does not have the Group-Aware RLinkX functionality.
Blue	Full redundancy: for all groups that are a member of this port. There is at least one redundant path.

GLOBAL RLINKX STATUS LED

GigaCores have a 'Global' RLinkX LED:

Colour	Meaning
OFF	No ports on this switch have RLinkX enabled.
Orange	At least one port on this switch is in the 'partial' redundant state.
Green	There are no partial redundant ports on this switch.

WEB INTERFACE

These are the indications you will see in the GigaCore web interface:

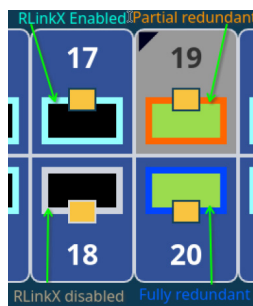

3.2 Groups (VLANs)

The groups function allows the user to segment the network into several virtual networks (VLANs). The main benefit of this function is that no group will affect the other groups, on protocol level. The user can create several groups on the network, and each device included in a group will be able to communicate with devices in this group only. This will result in no protocol conflict.

Three groups have been created in the illustration below: Red, Green and Blue. Each device included in each group can communicate with devices from the same group only. Thus, the sound console and the sound processor can talk to each other without being flooded by packets streamed by the two other groups.

The GigaCore 16tf switches offer 20 pre-defined groups, and offer the user the option to add additional groups, to which the user can assign any of the ports. Two devices must be part of the same group to communicate.

When more than one one switch is used in a group-based network, the **Inter Switch Link** group (ISL Group-0) must be used to forward the groups between switches.

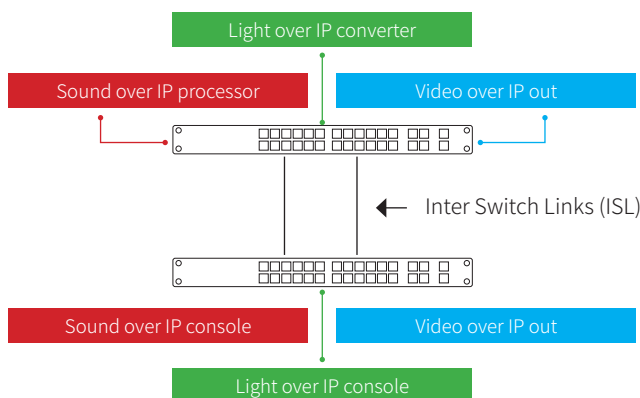

3.3 MultiLinkX

MultiLinkX is Luminex's link aggregation protocol. It is based on the standard IEEE Link Aggregation Control Protocol (LACP). Other terms for link aggregations are 'trunking', 'bonding' or 'bundling'.

With MultiLinkX, multiple physical connections can be combined into a single virtual connection. This increases the theoretical bandwidth and the resilience of the connections.

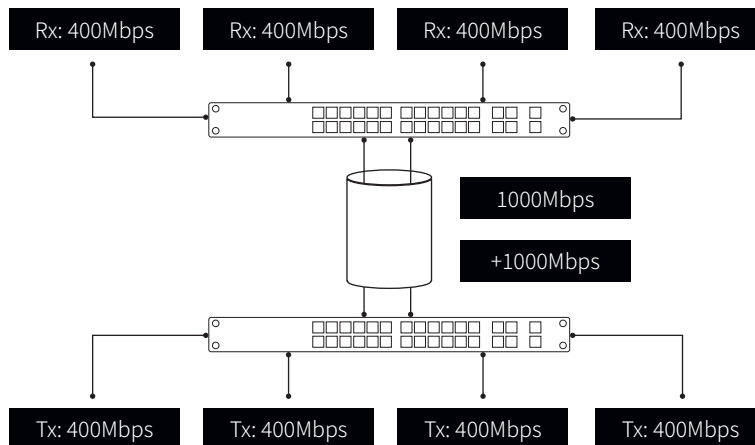

MultiLinkX technology is available on trunk ports. This includes the ISL (inter-switch link) and Custom Trunk ports.

1 + 1 IS NOT 2!

By adding an additional link into the aggregation, it's easy to think you'll have double the bandwidth available.

However, MultiLinkX relies on LACP (Link Aggregation Control Protocol). The algorithm used by the protocol requires several parameters of the Ethernet frame to decide to which port of the aggregation the frame will be forwarded.

The protocol uses the following parameters:

- Source MAC Address.
- Source IP Address.
- Source Port (TCP/UDP).
- Destination IP Address.
- Destination Port (TCP/UDP).
- The ports included in the aggregation.

In some circumstances it might happen that several data streams will be forwarded to the same port. Therefore, you might still get bandwidth limitations when using MultiLinkX, even though the theoretical maximum bandwidth of the aggregation isn't reached yet.

Once MultiLinkX is enabled on the ISL ports, a Magenta bar will appear below/above the selected ports.

Once MultiLinkX is active on the ISL ports, the Magenta bar will turn White.

4. Configuration

In the next paragraphs we will describe how to configure your GigaCore switch via the build-in web interface. Alternatively, you can configure your switch using Araneo. Araneo is available for Windows and MacOS and can be found in the download section of our website: <http://www.luminex.be/download-araneo/>.



PLEASE KEEP IN MIND, THE WEB INTERFACE OF A SWITCH CAN ONLY BE REACHED THROUGH A PORT ASSIGNED IN THE MANAGEMENT GROUP (FROM THE SWITCH YOU ARE CONNECTED TO, OR FROM ANOTHER SWITCH THROUGH AN ISL PORT). YOU NEED AT LEAST ONE PORT ASSIGNED TO THE MANAGEMENT GROUP IN YOUR ENTIRE NETWORK TO REACH THE WEB INTERFACE OF ALL YOUR GIGACORE SWITCHES.

FACTORY DEFAULT, ALL PORTS ARE ASSIGNED TO THE MANAGEMENT GROUP.

WEB INTERFACE PRESENTATION

Launch your favourite web browser and type the IP address of your GigaCore. Press enter to validate. Use **admin** in the user field and leave the password field **blank**.





4.1 Status Page

(A) Identify: Clicking on the Luminex logo will identify your GigaCore in the network. The switch LEDs will flash green for 5 seconds. In the web-UI, the text “Identified” will be displayed under the logo.

(B) Drawing of your GigaCore: This product image gives you a quick overview of the switch port status. Active ports are filled with the following colours:

- Orange: 100Mbps link
- Green: 1000Mbps (1Gbps) link
- Green SFP+: 10000Mbps (10Gbps) link

(C) **E-Ink display:** showing all the active options the switch has to offer:

- 1Gb 
- 10Gb 
- PoE 
- Single-Mode fiber 
- Multi-Mode fiber 

(D) **PSU's:** On the right-hand side of the switch image, two icons indicate the status of the installed PSU's.

Here is a list of the icons, the possible colours, and the meaning of each colour:

Non PoE models		
		Green PSU present and online.
		Orange PSU present but not powered (only when 2x PSU are fitted).
		Red PSU error.
		Green PSU redundancy configured and active.
		Orange PSU redundancy configured but not available.
		Orange Warning.
		Grey No PSU present.
PoE models		
		Green PSU present and online.
		Orange PSU present but not powered.
		Red PSU error.
		Green PSU redundancy configured and active.
		Orange PSU redundancy configured but not available.
		Green PSU sharing configured and active.
		Orange PSU sharing configured but not available.
		Orange Warning.
		Grey No PSU present.
		Green Non PoE capable PSU present and online.
		Orange Non PoE capable PSU present but not powered (only when 2x PSU are fitted).
		Red PSU error.

(E) **Navigation menu**

(F) **Theme and language:** Select here if you want to use the dark or light theme.

Interface supported languages are English, Japanese and Chinese for now.

(G) **Help:** In case you need help, here you find an on-board help file.

(H) **Port status:** This table gives you a quick overview of the port settings.

(I) **IP Settings:** Find here all the network settings of the switch. These parameters can be modified in the device settings menu.

(J) **System info:** Find here all the information of the device such as system identifier, device name, system description, MAC address, serial number, and current firmware version. This information can be modified in the device settings menu.

(K) **Active profile:** In this area, the current active profile of the GigaCore is being displayed.

4.2 Groups/Trunks

Groups is a technology which offers the user to easily segment the network into several virtual networks (VLANs). This menu allows the user to assign ports to one of the 20 embedded groups of the switch. A group is a combination of ports and the user can assign as many ports to a group as they require.

The GigaCore range offers three types of groups:

- **Trunk 1 (ISL):**
This group is dedicated to the Inter Switch Link (Trunk). This is the name given to the interconnection links between GigaCore switches in a network. The ISL links are meant to forward the group-based packets for the default 20 pre-defined groups.
- **Custom Trunk:**
The GigaCore 16tf offers the user to create custom trunks.
- **Group 1 (Management):**
This group is dedicated to the management of the switch (web interface). You need to have at least one port of the switch assigned to the management group in order to be able to reach the web interface. In a star, ring or mesh network topology comprised of GigaCore switches, you need to have at least one port on one of the switches set to this group in order to be able to reach the web interface of any of the switches.
- **Group 2 onwards: (including custom groups)**
These are the generic groups to be used for any purpose such as sound, lighting, intercom, video....
The GigaCore 16tf offers 20 pre-defined groups but if required, the user can add more groups in the Edit groups section.

To assign ports to a group, please follow the following steps:

1. **Select the group** you wish to assign ports to.
2. **Select the ports** you wish to assign to the group. Selected ports will be highlighted.
3. **Click Apply** to assign the ports to the group. The selected ports will now change to the colour of the selected group.

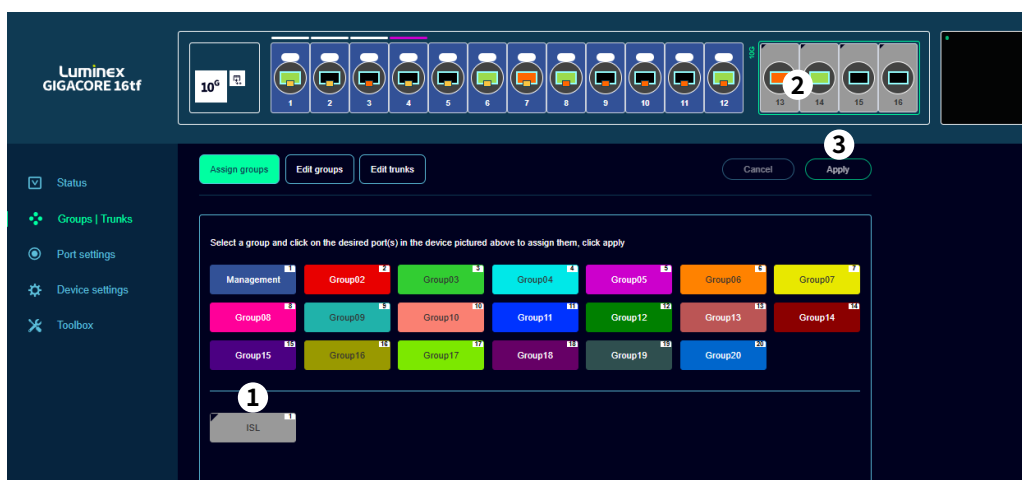

PLEASE KEEP IN MIND, THE WEB INTERFACE OF A SWITCH CAN ONLY BE REACHED THROUGH A PORT ASSIGNED TO THE MANAGEMENT GROUP (FROM THE SWITCH YOU ARE CONNECTED TO, OR FROM ANOTHER SWITCH THROUGH AN ISL PORT). YOU NEED AT LEAST ONE PORT ASSIGNED TO THE MANAGEMENT GROUP IN YOUR ENTIRE NETWORK TO REACH THE WEB INTERFACE OF ALL YOUR GIGACORE SWITCHES.

GROUP/VLAN ADVANCED SETTINGS

To change the settings for a group, click on the Edit groups option.

With the group selected you can:

- Change the name for ease of identification.
- Set the VLAN ID (default is group number x 100).
- Change the colour to your liking.
- Enable/disable IGMP Snooping (default is ENABLED).
- Enable/disable IGMP Querier (default is ENABLED).
- Enable/disable IGMP unknown flooding (default is DISABLED).
- Enable/disable IGMP Fast Leave (default DISABLED).
- Set a IGMP Querier mode (Default, Primary, Secondary or Custom).
- Enable/disable AVB
- Set Clock mode (Transparent, Boundary, Replicate or Disabled).

Once all the settings are correct, click **Apply** to confirm the changes.

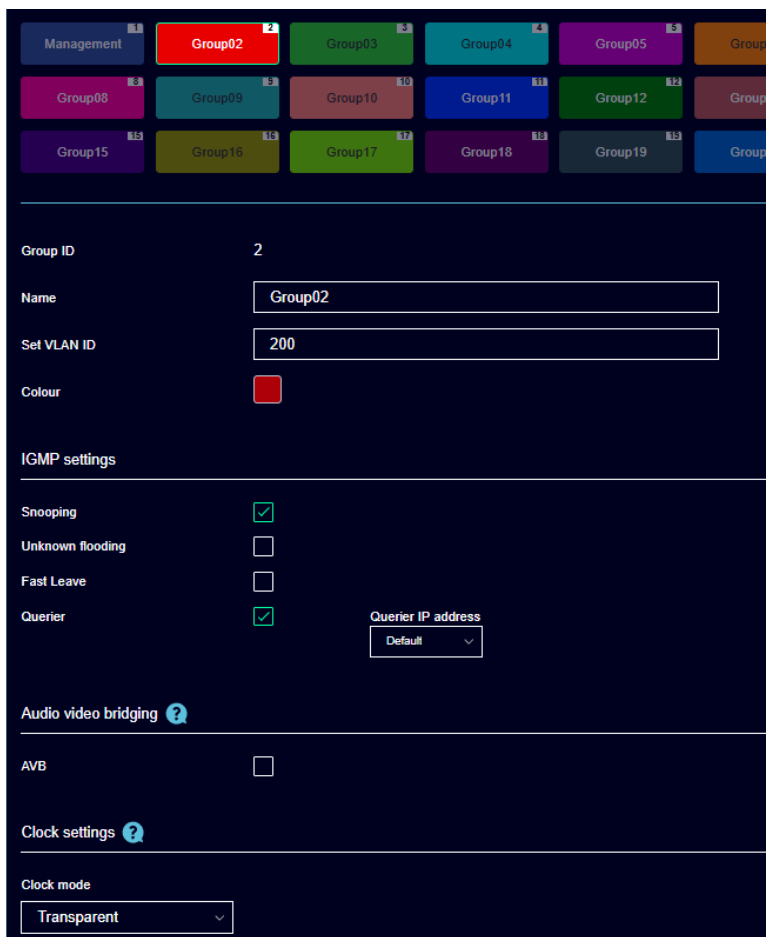

Management Group02 Group03 Group04 Group05 Group06

Group08 Group09 Group10 Group11 Group12 Group13

Group15 Group16 Group17 Group18 Group19 Group20

Group ID 2

Name Group02

Set VLAN ID 200

Colour ■

IGMP settings

Snooping

Unknown flooding

Fast Leave

Querier Querier IP address
Default

Audio video bridging ?

AVB

Clock settings ?

Clock mode
Transparent

ADD OR EDIT A TRUNK

To Add or Edit a trunk, click the Edit trunks option.

To Add a custom trunk:

- Click the + to add a trunk.
- Enter a trunk ID.
- Give the new trunk a name in the name field.
- Assign a colour to the trunk by clicking on the coloured square. After selecting the colour, click anywhere outside the colour picker window to close it.
- Click on all the groups/VLANs you wish to include in this trunk.
- If needed, use the drop-down menu for Untagged to select which group should be untagged on the trunk. An untagged port connects to hosts. The host is unaware of any VLAN configuration.
- Enable/disable MultiLinkX

Once all the settings are correct, click **Apply** to confirm the changes. Your custom trunk is now available in the Assign groups tab to be assigned to ports.

If you wish to change the trunk ID, you can use the Move button to assign a new trunk ID.

DELETE A TRUNK







To delete a custom trunk, select the trunk you wish to delete in the Edit trunks window and click the delete button. All ports that were assigned to the custom trunk are automatically re-assigned to the Management group.

4.3 Port settings

This menu allows you to change the following settings:

- **RLinkX**: enable/disable RLinkX per port (default is ENABLED).
- **Legend**: add a legend for easy identification.
- **Port speed**: set the port speed (default is Auto).
- **PoE**: enable/disable PoE (if the switch doesn't support PoE this feature is greyed out).
- **PoE Priority**: set the PoE priority.
- **Disable link**: when disabled, the port is displayed greyed out and a red cross is shown in front of the port on the status page. This does not impact the PoE state.
- **Protect**: when enabled, the port settings can not be changed. A padlock icon is displayed on the port at the top of the page and in front of the port on the status page.

When all settings are as you wish, click **Save** to apply the changes.

Port	RLinkX	Legend	Port speed	PoE	PoE Priority	Disable link	Protect
1		Port 1	Auto		low	<input type="checkbox"/>	
2		Port 2	Auto		low	<input type="checkbox"/>	

AVAILABLE PORT SPEEDS FOR PORT 1-12

- Auto: The port automatically detects the speed of the connected device (default).
- 1Gbps FDX: 1000Mbps Full Duplex.
- 100Mbps FDX: 100Mbps Full Duplex.
- 100Mbps HDF: 100Mbps Half Duplex.
- 10Mbps FDX: 10Mbps Full Duplex.
- 10Mbps HDX: 10Mbps Half Duplex.

AVAILABLE PORT SPEEDS FOR PORT 13-16

- Auto: The port automatically detects the speed of the connected device (default).
- 10Gbps: 10000Mbps Full Duplex.
- 1Gbps FDX: 1000Mbps Full Duplex.

4.4 Device settings

The device settings page is divided in nine sub menus:

IP SETTINGS

Assign here the IP mode and IP address of your switch. This IP address will be used to reach the switch's web interface. The default IP address can be found at the rear of the device or on the E-ink display. There is one IP mode available:

- **Static** (default)
Enter your preferred IP address and the subnet mask. Enter your default gateway IP address if your switch needs to be reached from a routed network. Press apply to save your setting.
- **Link-Local** (zero-conf)
When using Link-Local, the switch will auto assign an IP address in the range 169.254.x.x/16.
- **DHCP** (Dynamic Host Configuration Protocol)
If your network is equipped with a DHCP server, you can enable the DHCP client of the switch for it to receive an IP address automatically from the DHCP server. When DHCP is enabled, the user can choose to use a static address or the link-local option as fallback IP address in case the DHCP server is not available at bootup.

Other options available in the IP Settings menu are to enable or disable mDNS discovery (default is enabled) and to show or hide the IP address on the E-ink display (default is enabled).

ID SETTINGS

Here you can set the ID number of the switch and give the device a name and description to easily identify your switch in the network and to use in Araneo to map an offline to online deployment.

SECURITY

The user can use this feature to set a password to protect the access to the web interface. The default login for the web interface is:

Username: admin

Password: No password

DEVICE INFO

The device info window shows:

- Model.
- MAC address.
- Serial number of your device.

GENERAL POE SETTINGS

The general PoE settings allow you to set:

- Power allocation:
 - Consumption**, the actual consumed power is being used to determine the budget of the complete PSU PoE budget.
 - Reserved**, the class is used to reserve the maximum allowed power for that class to determine the total reserved PoE budget of the PSU.

If the switch does not support PoE, this section is greyed out.

SNMP

Enable/disable SNMP (Simple Network Management Protocol). Here you can configure whether you want to use SNMP. By default SNMP is disabled.

RESET OPTIONS

- **Default Profile:** Here the user can choose to set the profile in slot #1 as default profile. By clicking the check-box, the user can protect the profile stored in slot #1 from being deleted or overwritten. When the user performs a Reload Defaults from the front panel mode button (see Reload Default in the Reset chapter of this manual), the device will reboot into profile #1. This is a handy tool to quickly recall your favourite profile. Once the first profile is protected and set as default, a padlock will appear on slot 1 on the profile tab.
- **Disable reset via Mode button:** When enabled, the mode button only allows the rest option during the first 2 minutes from boot-up. Once this time has passed, the mode button can no longer be used to reset the switch.

LED BRIGHTNESS

The LED slider allows you to change the brightness of the port mode LEDs and the status LEDs on the GigaCore. The port mode LEDs can be dimmed to OFF but the status LEDs will always stay visible. The brightness of the link LEDs is not affected.

E-INK SETTINGS

The following options are available:

- Standard or custom background. When custom is chosen, the user can upload a custom background image to the screen. The image needs to be a PNG and has to be 200px by 200px in size.
- Show/hide the IP address of the switch on the E-ink display.
- Invert the colours on the E-ink display.

4.4 Toolbox

The toolbox page is divided in four sub menus:

PROFILE MANAGER

The profile manager allows the user to save, recall, export or import a configuration.

A profile contains the following parameters:

- Device settings.
- Port settings.
- RLinkX settings.
- Group settings.
- PoE settings.

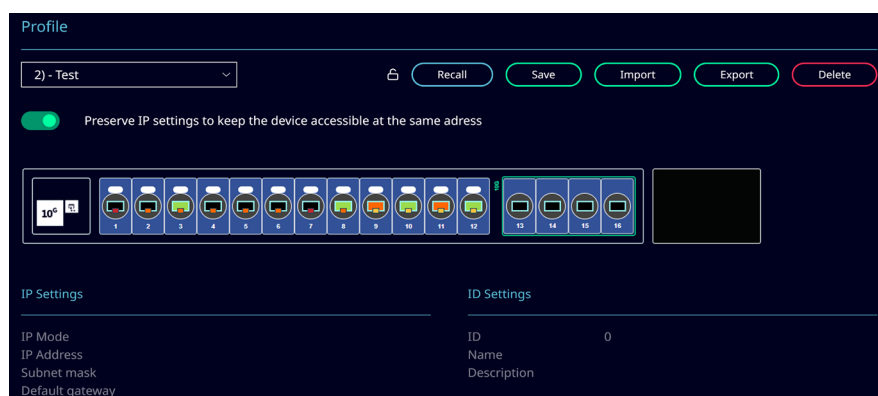

This way, the user can create a comprehensive configuration for a switch, save it as a profile, and recall it later when needed.

A maximum of forty profiles can be saved on a GigaCore 16tf switch. The switch also offers to export or import a profile through a computer, providing the user with an easy way to exchange profiles between switches.

RECALL A PROFILE

Select the profile with the drop-down menu. Once a profile is selected, a preview of the configuration is shown below the drop-down in graphic form.

With the slider, the user can choose to preserve the current IP settings of the switch or to reload the IP settings stored in the profile. By default the current IP address is preserved.

FIRMWARE

In the firmware section, two versions of firmware are shown:

- **Active firmware:** is the one currently running on the device.
- **Alternate firmware:** is the previously installed firmware.

If you would like to downgrade the device to the previously installed firmware, click on the activate button. The device will reboot in this firmware.

FIRMWARE UPGRADE

You can upgrade the GigaCore 16tf with our latest firmware. The quickest and most convenient way to upgrade your device(s) is with the Araneo software.

Alternatively, you can upgrade the device via the build-in web-UI. To upgrade the device, please apply the following procedure:

- Download the latest firmware from the support section of our web site. <http://www.luminex.be/support-2/product-downloads/>
- Extract the downloaded archive and have a look at the release notes included.
- Click on the firmware upgrade button in the web-UI of your device.
- Select the file you have extracted.
- The GigaCore will start the firmware upgrade. The device will reboot after the upgrade is completed.

RESET

In this panel, you can reset the GigaCore, with two separate options:

- Preserve IP address, all settings get restored to factory default apart from the IP address set to reach the device. All saved profiles will be lost.
- Preserve profiles, during the reset the custom stored profiles are being kept.

Click on the Reset button to perform the selected reset.

Performing a reset with these two options disabled will bring the GigaCore to its factory settings.

REBOOT

Press the “Reboot” button to reboot the device. All settings will be preserved.

5. Reset

In the case you need to reset the unit without the web interface or Araneo, the GigaCore 16tf offers different levels of reset, based on the ones you can find in the web interface or Araneo.

- **Reset:** The unit is brought back to its default configuration, with the default IP address that can be found on the rear of the device or on the E-ink display. Profiles stored in the device are preserved.

Default login: admin

Default password: No password

- **Reload Defaults:** The profile stored in slot one is reloaded. The “Reload Default” is available only if the profile stored in slot one has been locked through the utility menu. If this profile is set with a password, then the user will need to enter it through the web interface to access the switch’s menu.

Default login: admin

Default password: No password

- **Factory Reset:** With a factory reset the device is fully reset to the state it left Luminex and ALL data will be erased.

Default login: admin

Default password: No password



RESETTING THE DEVICE WITH THE MODE BUTTON IS AVAILABLE IF THE MODE BUTTON HAS NOT BEEN DISABLED IN DEVICE SETTINGS OR, IF DISABLED IN DEVICE SETTINGS, WITHIN 2 MINUTES AFTER BOOTING THE SWITCH.

The different reset options in more detail:

5.1 Reset

Condition 1: The device is currently running.

Condition 2: There is no profile set as default profile.

Hold the mode button for at least five seconds until the four status LEDs are flashing red. Releasing the mode button whilst the status LEDs are flashing will reset the unit.

Be aware, releasing the mode button before the status LEDs start flashing red, or after the LEDs have stopped flashing red, will cancel the operation.

Hold the mode button



Release the button = Reset



Release the button = Cancel



Function



5.2 Reload defaults

Condition 1: The device is currently running.

Condition 2: The profile stored in slot one needs to be locked through the device settings menu.

Hold the mode button for at least five seconds until the four status LEDs start flashing green. Releasing the mode button whilst the status LEDs are flashing green will reboot the switch into the profile stored in slot one.

If you keep the mode button pressed for another 5 seconds, the status LEDs will start flashing red to provide you with a reset.

Be aware, releasing the mode button before the status LEDs start flashing green, or after the LEDs have stopped flashing red, will cancel the operation.

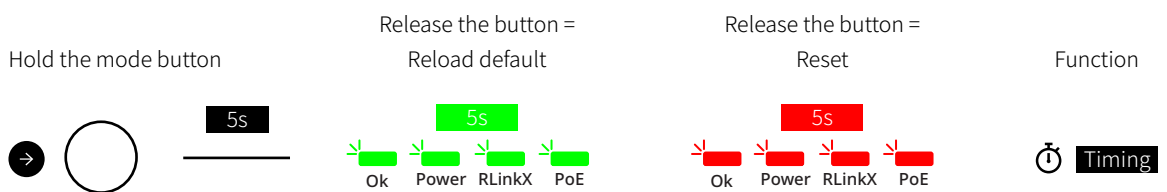

5.3 Factory Reset

Condition 1: The device is switched off.

Hold the mode button while connecting the device to mains power. After approx. 42 seconds, the four status LEDs will start flashing red. Releasing the mode button whilst the status LEDs are flashing red will factory reset the device. All customer stored profiles will be erased.

Be aware, releasing the mode button before the status LEDs start flashing red, or after the LEDs have stopped flashing red, will cancel the operation.

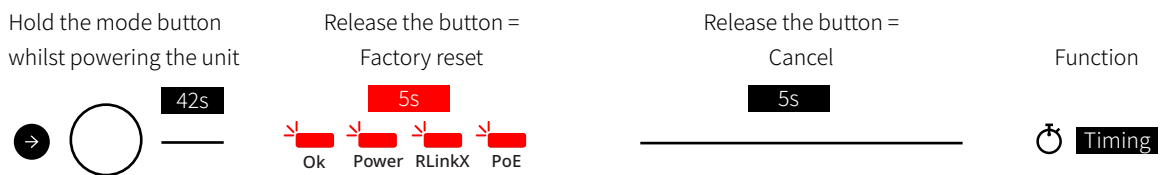

6. Technical Support

Sometimes it is required to get more help with your device or application. There is a knowledge base available online that gets updated on a regular basis at: <https://support.luminex.be>

If you need to ask our team for more help or you need to return a device to Luminex for diagnostics or repair, you can also find the option on this page to request an RMA or start a support ticket.

7. Technical Specifications

GIGACORE 16TF

MECHANICAL	
Enclosure	Robust all metal housing
Dimensions (W x D x H)	482 x 237.6 x 44 mm (19" x 9.35" x 1.73")
Material thickness	2 mm
Mounting type	Rack mount
Weight	4.0 kg
Packaging dimensions	550 x 335 x 68 mm
Packaged weight	4.24 kg
CONNECTIVITY	
Network	12x Gigabit (10/100/1000 BASE-T) EtherCON connectors on front panel
	2x 10Gbps / 1 Gbps rugged fiber connectors on front panel, independent from other ports AND
	2x 10Gbps / 1 Gbps rugged fiber connectors on rear panel, independent from other ports OR
	4x 10Gbps / 1 Gbps rugged fiber connectors on rear panel, independent from other ports
Power	1x PowerCON TRUE1 in/out
Backup power	Through proprietary connector and optional RPSU (PoE model only)
Backup PoE	Through proprietary connector and optional RPSU
TEMPERATURE MANAGEMENT	
Intelligent control	Yes
Number of fans	2
Position of fans	Side panel
Airflow direction	Right to left to rear
USER INTERFACE	
Device status	4x RGB LED
	• Ok
	• Power
	• RLinkX
	• PoE
LCD Display & Jog	No
Dynamic labelling	E-ink display
Fiber port status	2x RGB LED
	Port Speed/Activity
	Port Status
	• Group indication
Copper port status	2x RGB LED
	Port Speed/Activity
	Port Status
	• Group indication
	• PoE
FIBER PORT SPECIFICATIONS	
Port speed	10G BASE-X or 1000 BASE-X
Port sensing	Fixed speed
RJ45 PORT SPECIFICATIONS	
Port speed	10/100/1000 BASE-T
Port sensing	Auto Negotiation
Auto crossover	MDI/MDIX (allows use of straight or cross wired cable)
Auto sensing	Full or Half Duplex (Gigabit is Full Duplex)

POWER OVER ETHERNET	
Standards	802.3af
	802.3at
	802.3bt
PoE Ports	802.3af, 802.3at, 802.3bt
Total PoE power budget	450W (Mains ONLY)
	850W (With RPSU 5580)
LLDP Support	Yes
Power allocation	User configurable:
	<ul style="list-style-type: none"> • Priority per port • Consumption vs Class/LLDP based
Power limit	• Total power budget firmware limit - port shutdown at overload based on port priority
	• Per port hardware and firmware power limits based on classification - port shutdown at overload
SWITCH FEATURES	
Boot time	45 s
Redundant links (RLinkX)	Yes
Link Aggregation (MultiLinkX)	Yes
Group function	Yes
Ethernet compliance	IEEE 802.2
	IEEE 802.3
	IEEE 802.3u
	IEEE 802.3x Flow Control
	IEEE 802.3ab Gigabit Ethernet
	IEEE 802.3af PoE
	IEEE 802.3at PoE+
	IEEE 802.3bt PoE++ 90W
	IEEE 802.3ae
	IEEE 802.1p CoS
	IEEE 802.1d Spanning Tree
	IEEE 802.1w Rapid Spanning Tree
	IEEE 802.1s Multiple Spanning Tree
	IEEE 802.1Q VLAN
	IEEE 802.1Qav MVRP
	IEEE 802.1 BA-2011 -> AVB (Audio Video Bridging)
	IEEE 802.1ab LLDP
IEEE 1588-2008 PTPv2	
IETF RFC2710	
IETF RFC3810	
Jumbo frames	Yes, supported up to 12000 MTU (with restrictions when using AVB)
Supported protocols	Avnu AVB/Milan (Available in future FW update)
	Dante
	RAVENNA/AES67
	Ethersound
	Q-SYS/Q-LAN
	IPMX
	sACN
	ArtNet
	MANet
	HogNet
RTTrPL (BlackTrax)	
...	

7 | TECHNICAL SPECIFICATIONS

Audio protocol compliance	Yes, low jitter and hardware timestamping (IEEE 1588-2008)
Ethernet switch type	Full non-blocking wire-speed switching performance
Memory	Flash 1 Gb RAM - 8 Mb NOR flash 4 Gb EMMC storage
MAC Address table	16384 entries
Address learning / aging	Self learning, Auto aging
Switching Capacity	104 Gbps (10Gbps versions)
Switching throughput	77381 Mbps
IGMP Querrier	Yes (V1, V2) (V3 compatible)
IGMP Snooping	Yes, enabled by default (V1, V2, V3)
MANAGEMENT	
Configuration	Built-in WebUI
Network wide configuration	Yes, with Araneo software
Firmware upgrades	Via WebUI or network wide with Araneo - contingency option with second firmware file stored
POWER	
Power input	100-240 VAC
Backup power	Yes with 2nd PSU (Note the second PSU connectivity is only offered on the PoE++Models.)
Backup PoE	Yes with 2nd PSU
Power consumption	Max 50W - Max 1050W (Depending on PoE and PSU configuration)
ENVIRONMENTAL	
Operating temperature	0 to +50 °C
Storage temperature	-10 to +70 °C
Humidity (non condensing)	5 to 95% RH
APPROVALS	
Electromagnetic emissions and immunity	FCC Part 15 CFR 47 class A
	CAN/ICES-003
	EN 61000
	EN 55032
Safety	EN 55024
	IEC 62368-1
	EN 62368-1
	UL 62368-1
Certificates and approvals	CAN/CSA-C22.2 No. 62368-1
	cSGSUS Mark (UL)
	CE Mark
	UKCA Mark
Green	CB Certificate
	RoHS
	REACH

DISCLAIMER

Luminex LCE operates a policy of continuous development. Luminex LCE reserves the right to make changes and improvements to any of the products described in this document above without prior notice. Specifications are subject to change without notice.

Copyright © 2002-2025.

All rights reserved.

No part of this documentation may be reproduced or transmitted in any form or by any means, electronic or mechanical, including photocopying and recording, without the prior written permission of Luminex. The information in this documentation is supplied without warranty of any kind, either directly or indirectly, and is subject to change without prior written notice. Luminex, its employees or appointed representatives will not be held responsible for any damages to software, hardware, or data, howsoever arising as a direct or indirect result of the product(s) mentioned herein.

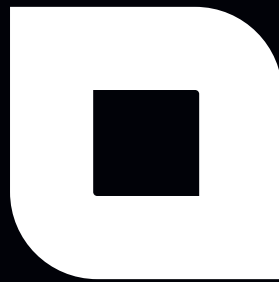

Luminex

Slamstraat 13 | 3600 Genk | Belgium | T +32 11 812 189
info@luminex.be | www.luminex.be